

KAURI Ceramic Pendant

MLCMP001ANTBRS Antique Brass



MATERIAL	Brass
HEIGHT	20cm 7.87"
WIDTH DIAMETER	20cm 7.87"
LENGTH PROJECTION	n/a
WEIGHT	1.1KG 2.43lbs
LAMPHOLDER	E27 x 1
MAX WATTAGE	40W x 1
VOLTAGE	220/240v
IP RATING	20
CLASS PROTECTION	I
SHADE	MLCS001
FLEX BAR CHAIN LENGT	100cm 40"
CABLE TYPE	MLCA047 2 Core Round Brown Braid PVC

Fixing Bracket MLROSE39 | Antique Brass

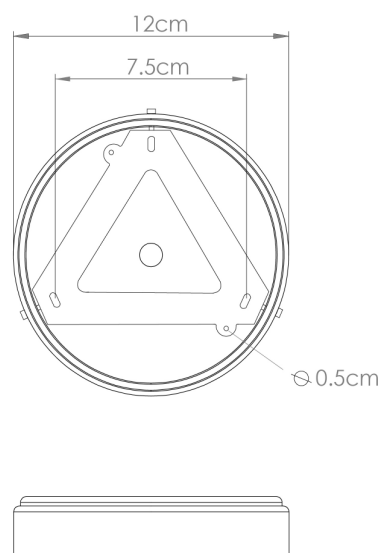

Product Notes:

1) Lamps not included with light fixture. 2) All products are individually hand crafted, therefore may differ slightly within manufacturing tolerances. 3) Please refer to: <http://www.mullanlighting.com/terms> for full list of Terms & Conditions. 4) Cable/Chain can be shortened during installation. 5) Longer Cable/Chain available on request. 6) Additional colour finishes available on request. 7.) Dimensions do not include lamps. 8.) Products wired to UL standards will operate at 110/120v with the appropriate lampholders.



MATERIAL	Brass
HEIGHT	20cm 7.87"
WIDTH DIAMETER	20cm 7.87"
LENGTH PROJECTION	n/a
WEIGHT	1.1KG 2.43lbs
LAMPHOLDER	E27 x 1
MAX WATTAGE	40W x 1
VOLTAGE	220/240v
IP RATING	20
CLASS PROTECTION	I
SHADE	MLCS001
FLEX BAR CHAIN LENGT	100cm 40"
CABLE TYPE	MLCA028 2 Core Round Black Braid PVC

Fixing Bracket MLROSE39 | Antique Silver

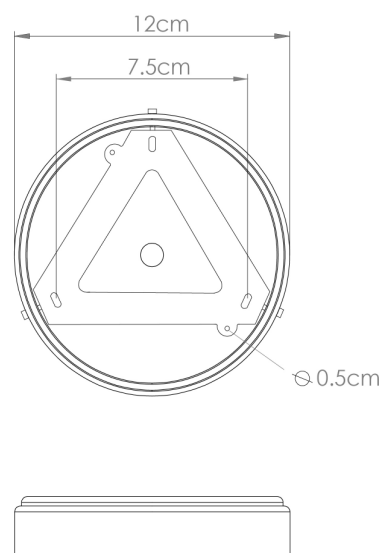
Product Notes:

1) Lamps not included with light fixture. 2) All products are individually hand crafted, therefore may differ slightly within manufacturing tolerances. 3) Please refer to: <http://www.mullanlighting.com/terms> for full list of Terms & Conditions. 4) Cable/Chain can be shortened during installation. 5) Longer Cable/Chain available on request. 6) Additional colour finishes available on request. 7.) Dimensions do not include lamps. 8.) Products wired to UL standards will operate at 110/120v with the appropriate lampholders.

KAURI Ceramic Pendant

MLCMP001POLBRS Polished Brass



MATERIAL	Brass
HEIGHT	20cm 7.87"
WIDTH DIAMETER	20cm 7.87"
LENGTH PROJECTION	n/a
WEIGHT	1.1KG 2.43lbs
LAMPHOLDER	E27 x 1
MAX WATTAGE	40W x 1
VOLTAGE	220/240v
IP RATING	20
CLASS PROTECTION	I
SHADE	MLCS001
FLEX BAR CHAIN LENGT	100cm 40"
CABLE TYPE	MLCA028 2 Core Round Black Braid PVC

Fixing Bracket MLROSE39 | Polished Brass

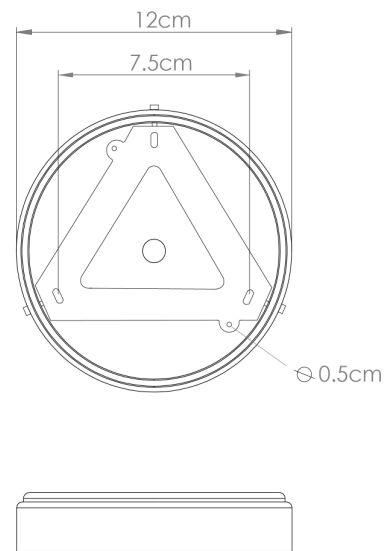

Product Notes:

1) Lamps not included with light fixture. 2) All products are individually hand crafted, therefore may differ slightly within manufacturing tolerances. 3) Please refer to: <http://www.mullanlighting.com/terms> for full list of Terms & Conditions. 4) Cable/Chain can be shortened during installation. 5) Longer Cable/Chain available on request. 6) Additional colour finishes available on request. 7.) Dimensions do not include lamps. 8.) Products wired to UL standards will operate at 110/120v with the appropriate lampholders.

KAURI Ceramic Pendant

MLCMP001SATBRS Satin Brass



MATERIAL	Brass
HEIGHT	20cm 7.87"
WIDTH DIAMETER	20cm 7.87"
LENGTH PROJECTION	n/a
WEIGHT	1.1KG 2.43lbs
LAMPHOLDER	E27 x 1
MAX WATTAGE	40W x 1
VOLTAGE	220/240v
IP RATING	20
CLASS PROTECTION	I
SHADE	MLCS001
FLEX BAR CHAIN LENGT	100cm 40"
CABLE TYPE	MLCA028 2 Core Round Black Braid PVC

Fixing Bracket MLROSE39 | Satin Brass

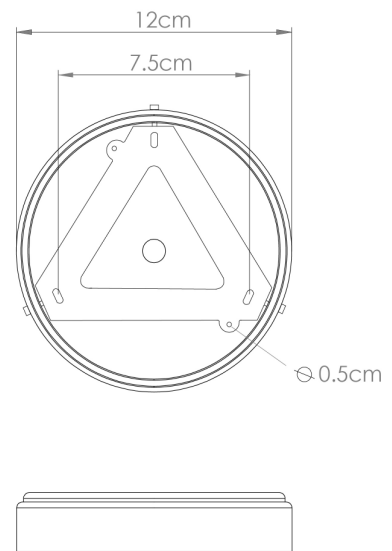

Product Notes:

1) Lamps not included with light fixture. 2) All products are individually hand crafted, therefore may differ slightly within manufacturing tolerances. 3) Please refer to: <http://www.mullanlighting.com/terms> for full list of Terms & Conditions. 4) Cable/Chain can be shortened during installation. 5) Longer Cable/Chain available on request. 6) Additional colour finishes available on request. 7.) Dimensions do not include lamps. 8.) Products wired to UL standards will operate at 110/120v with the appropriate lampholders.