

COPENHAGEN Pendant

MLP373PCBLK Black

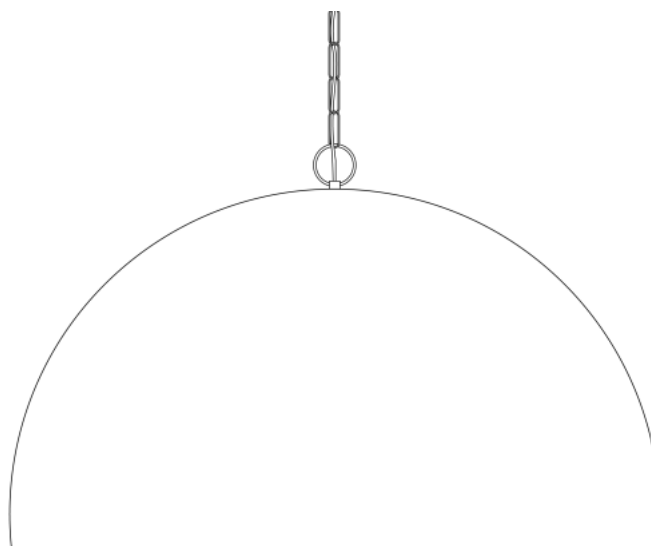

MATERIAL	Aluminium
HEIGHT	46cm 18.11"
WIDTH DIAMETER	73cm 28.74"
LENGTH PROJECTION	n/a
WEIGHT	4.1KG 9.04lbs
LAMPHOLDER	E27 x 1
MAX WATTAGE	60W x 1
VOLTAGE	220/240v
IP RATING	20
CLASS PROTECTION	I
SHADE	-
FLEX BAR CHAIN LENGT	100cm 40"
CABLE TYPE	MLCA029 3 Core Round Black Braid PVC

Fixing Bracket MLROSE15 | Black

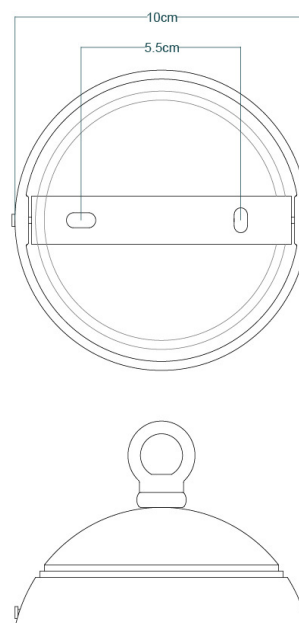

Product Notes:

1) Lamps not included with light fixture. 2) All products are individually hand crafted, therefore may differ slightly within manufacturing tolerances. 3) Please refer to: <http://www.mullanlighting.com/terms> for full list of Terms & Conditions. 4) Cable/Chain can be shortened during installation. 5) Longer Cable/Chain available on request. 6) Additional colour finishes available on request. 7.) Dimensions do not include lamps. 8.) Products wired to UL standards will operate at 110/120v with the appropriate lampholders.

COPENHAGEN Pendant

MLP373PCBRZ Bronze

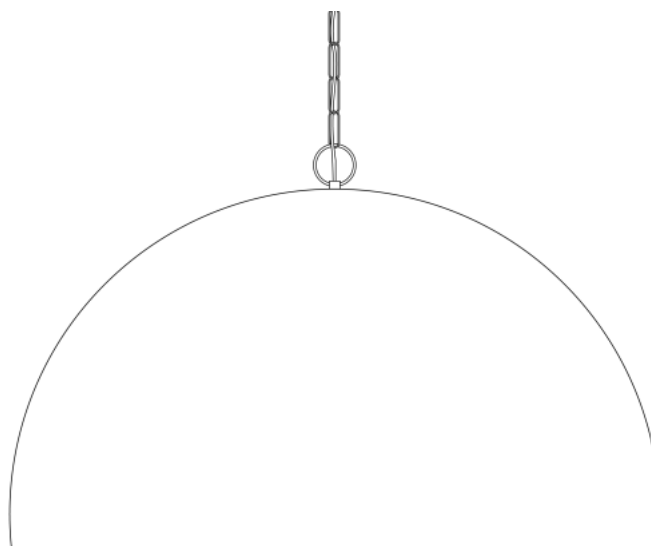

MATERIAL	Aluminium
HEIGHT	46cm 18.11"
WIDTH DIAMETER	73cm 28.74"
LENGTH PROJECTION	n/a
WEIGHT	4.1KG 9.04lbs
LAMPHOLDER	E27 x 1
MAX WATTAGE	60W x 1
VOLTAGE	220/240v
IP RATING	20
CLASS PROTECTION	I
SHADE	-
FLEX BAR CHAIN LENGT	100cm 40"
CABLE TYPE	MLCA029 3 Core Round Black Braid PVC

Fixing Bracket MLROSE15 | Antique Brass

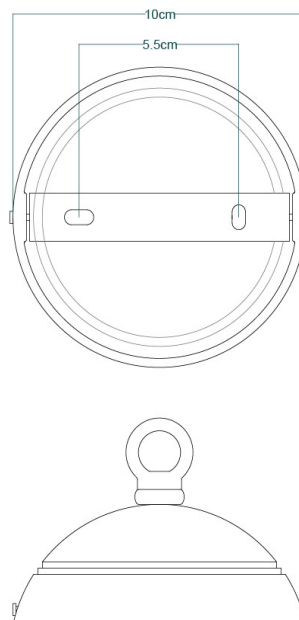

Product Notes:

1) Lamps not included with light fixture. 2) All products are individually hand crafted, therefore may differ slightly within manufacturing tolerances. 3) Please refer to: <http://www.mullanlighting.com/terms> for full list of Terms & Conditions. 4) Cable/Chain can be shortened during installation. 5) Longer Cable/Chain available on request. 6) Additional colour finishes available on request. 7.) Dimensions do not include lamps. 8.) Products wired to UL standards will operate at 110/120v with the appropriate lampholders.

COPENHAGEN Pendant

MLP373PCGRN Sage Green

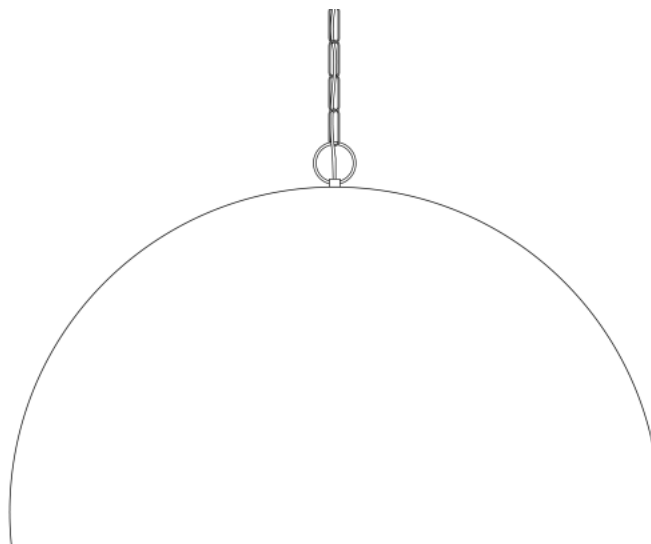

MATERIAL	Aluminium
HEIGHT	46cm 18.11"
WIDTH DIAMETER	73cm 28.74"
LENGTH PROJECTION	n/a
WEIGHT	4.1KG 9.04lbs
LAMPHOLDER	E27 x 1
MAX WATTAGE	60W x 1
VOLTAGE	220/240v
IP RATING	20
CLASS PROTECTION	I
SHADE	-
FLEX BAR CHAIN LENGT	100cm 40"
CABLE TYPE	MLCA029 3 Core Round Black Braid PVC

Fixing Bracket MLROSE15 | Sage Green

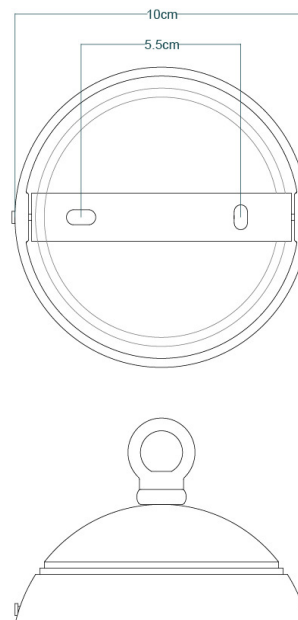

Product Notes:

1) Lamps not included with light fixture. 2) All products are individually hand crafted, therefore may differ slightly within manufacturing tolerances. 3) Please refer to: <http://www.mullanlighting.com/terms> for full list of Terms & Conditions. 4) Cable/Chain can be shortened during installation. 5) Longer Cable/Chain available on request. 6) Additional colour finishes available on request. 7.) Dimensions do not include lamps. 8.) Products wired to UL standards will operate at 110/120v with the appropriate lampholders.

COPENHAGEN Pendant

MLP373PCGRY Grey

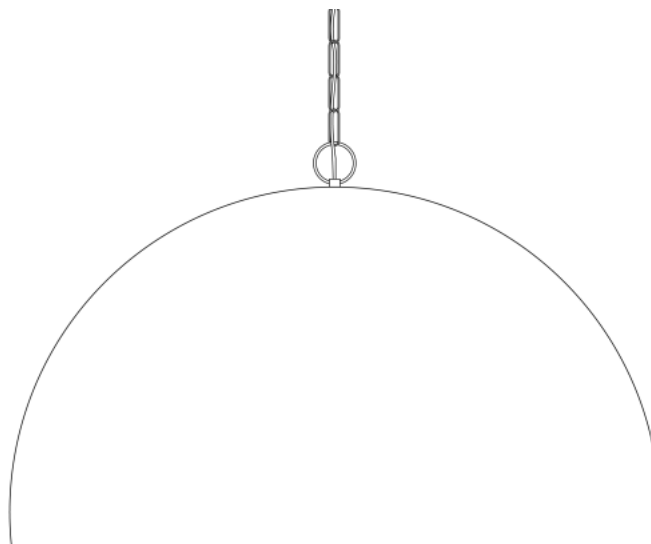

MATERIAL	Aluminium
HEIGHT	46cm 18.11"
WIDTH DIAMETER	73cm 28.74"
LENGTH PROJECTION	n/a
WEIGHT	4.1KG 9.04lbs
LAMPHOLDER	E27 x 1
MAX WATTAGE	60W x 1
VOLTAGE	220/240v
IP RATING	20
CLASS PROTECTION	I
SHADE	-
FLEX BAR CHAIN LENGT	100cm 40"
CABLE TYPE	MLCA029 3 Core Round Black Braid PVC

Fixing Bracket MLROSE15 | Grey

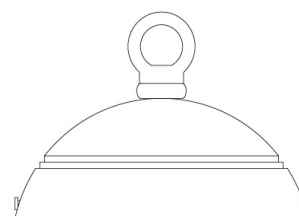
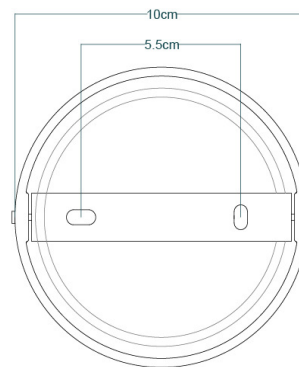

Product Notes:

1) Lamps not included with light fixture. 2) All products are individually hand crafted, therefore may differ slightly within manufacturing tolerances. 3) Please refer to: <http://www.mullanlighting.com/terms> for full list of Terms & Conditions. 4) Cable/Chain can be shortened during installation. 5) Longer Cable/Chain available on request. 6) Additional colour finishes available on request. 7.) Dimensions do not include lamps. 8.) Products wired to UL standards will operate at 110/120v with the appropriate lampholders.

COPENHAGEN Pendant

MLP373PCMBK Matt Black

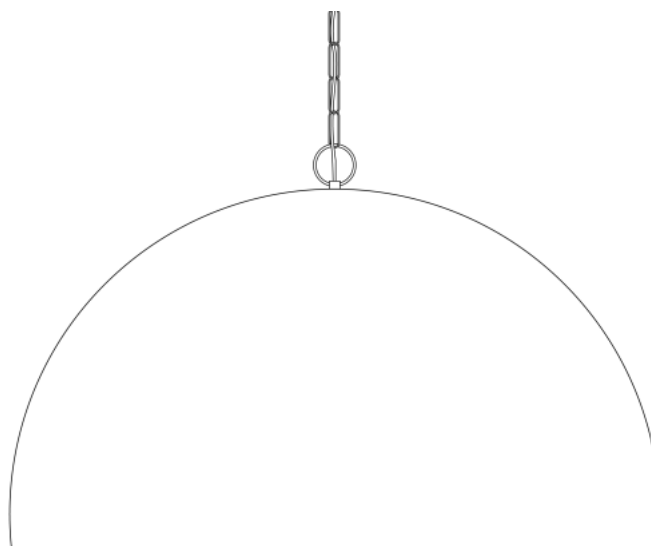

MATERIAL	Aluminium
HEIGHT	46cm 18.11"
WIDTH DIAMETER	73cm 28.74"
LENGTH PROJECTION	n/a
WEIGHT	4.1KG 9.04lbs
LAMPHOLDER	E27 x 1
MAX WATTAGE	60W x 1
VOLTAGE	220/240v
IP RATING	20
CLASS PROTECTION	I
SHADE	-
FLEX BAR CHAIN LENGT	100cm 40"
CABLE TYPE	MLCA029 3 Core Round Black Braid PVC

Fixing Bracket MLROSE15 | Matt Black

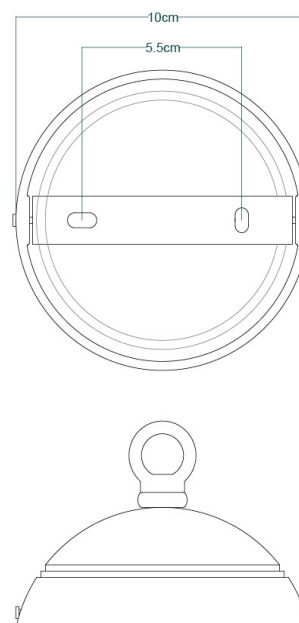

Product Notes:

1) Lamps not included with light fixture. 2) All products are individually hand crafted, therefore may differ slightly within manufacturing tolerances. 3) Please refer to: <http://www.mullanlighting.com/terms> for full list of Terms & Conditions. 4) Cable/Chain can be shortened during installation. 5) Longer Cable/Chain available on request. 6) Additional colour finishes available on request. 7.) Dimensions do not include lamps. 8.) Products wired to UL standards will operate at 110/120v with the appropriate lampholders.

COPENHAGEN Pendant

MLP373PCORG Orange

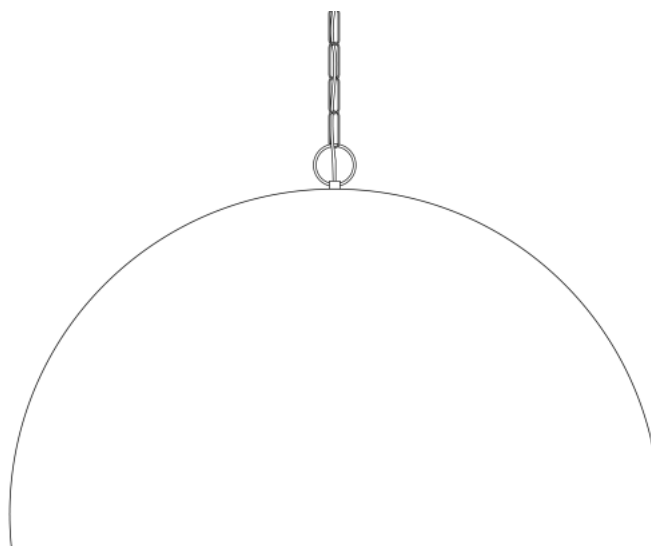

MATERIAL	Aluminium
HEIGHT	46cm 18.11"
WIDTH DIAMETER	73cm 28.74"
LENGTH PROJECTION	n/a
WEIGHT	4.1KG 9.04lbs
LAMPHOLDER	E27 x 1
MAX WATTAGE	60W x 1
VOLTAGE	220/240v
IP RATING	20
CLASS PROTECTION	I
SHADE	-
FLEX BAR CHAIN LENGT	100cm 40"
CABLE TYPE	MLCA029 3 Core Round Black Braid PVC

Fixing Bracket MLROSE15 | Orange

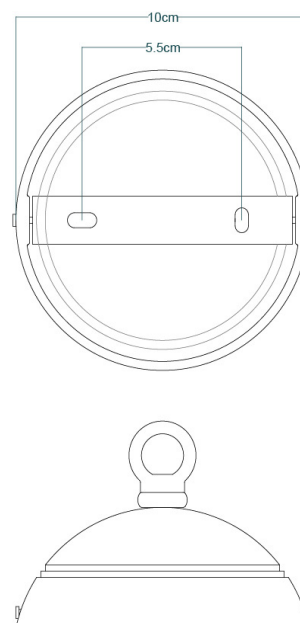

Product Notes:

1) Lamps not included with light fixture. 2) All products are individually hand crafted, therefore may differ slightly within manufacturing tolerances. 3) Please refer to: <http://www.mullanlighting.com/terms> for full list of Terms & Conditions. 4) Cable/Chain can be shortened during installation. 5) Longer Cable/Chain available on request. 6) Additional colour finishes available on request. 7.) Dimensions do not include lamps. 8.) Products wired to UL standards will operate at 110/120v with the appropriate lampholders.

COPENHAGEN Pendant

MLP373PCRED Red

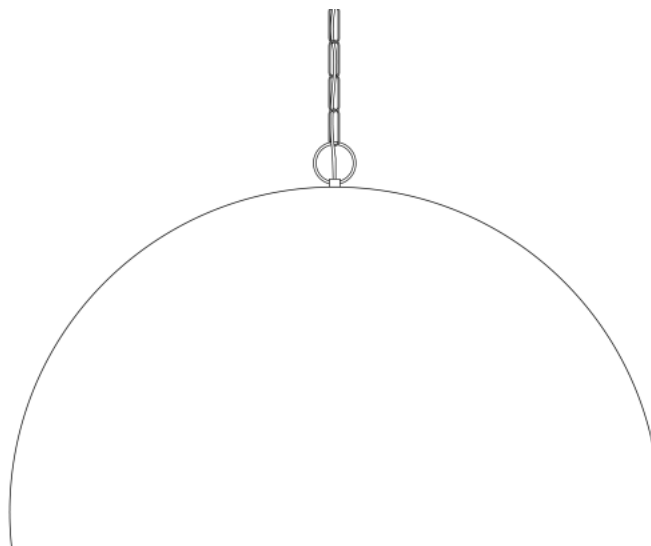

MATERIAL	Aluminium
HEIGHT	46cm 18.11"
WIDTH DIAMETER	73cm 28.74"
LENGTH PROJECTION	n/a
WEIGHT	4.1KG 9.04lbs
LAMPHOLDER	E27 x 1
MAX WATTAGE	60W x 1
VOLTAGE	220/240v
IP RATING	20
CLASS PROTECTION	I
SHADE	-
FLEX BAR CHAIN LENGT	100cm 40"
CABLE TYPE	MLCA029 3 Core Round Black Braid PVC

Fixing Bracket MLROSE15 | Red

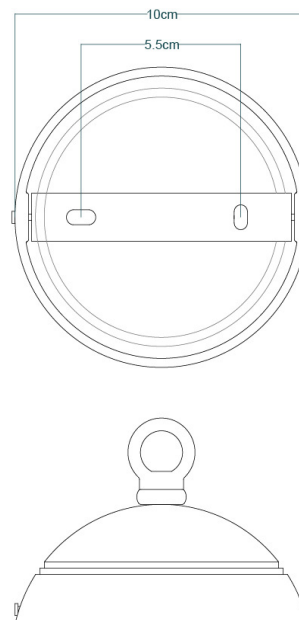

Product Notes:

1) Lamps not included with light fixture. 2) All products are individually hand crafted, therefore may differ slightly within manufacturing tolerances. 3) Please refer to: <http://www.mullanlighting.com/terms> for full list of Terms & Conditions. 4) Cable/Chain can be shortened during installation. 5) Longer Cable/Chain available on request. 6) Additional colour finishes available on request. 7.) Dimensions do not include lamps. 8.) Products wired to UL standards will operate at 110/120v with the appropriate lampholders.

COPENHAGEN Pendant

MLP373PCRGR Racing Green

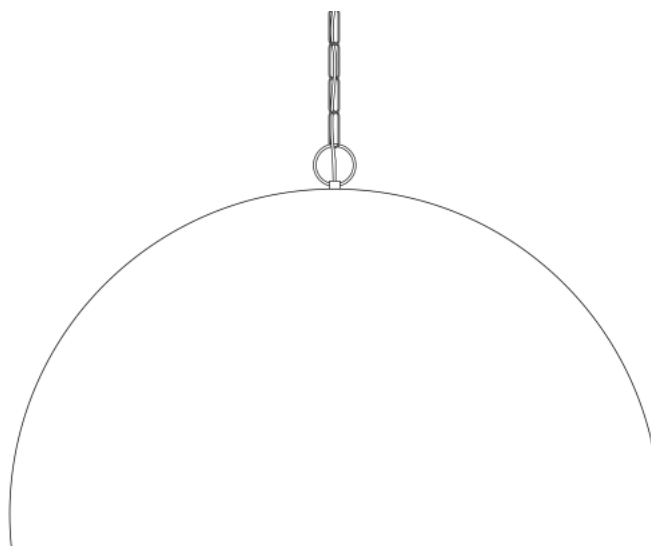

MATERIAL	Aluminium
HEIGHT	46cm 18.11"
WIDTH DIAMETER	73cm 28.74"
LENGTH PROJECTION	n/a
WEIGHT	4.1KG 9.04lbs
LAMPHOLDER	E27 x 1
MAX WATTAGE	60W x 1
VOLTAGE	220/240v
IP RATING	20
CLASS PROTECTION	I
SHADE	-
FLEX BAR CHAIN LENGT	100cm 40"
CABLE TYPE	MLCA029 3 Core Round Black Braid PVC

Fixing Bracket MLROSE15 | Racing Green

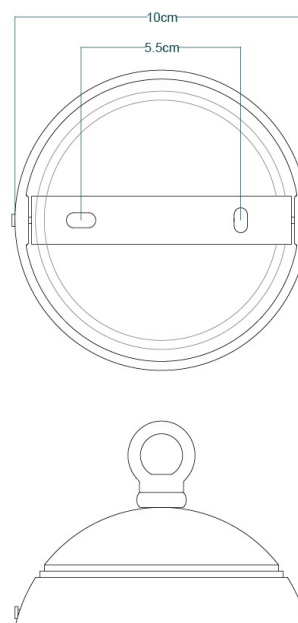

COPENHAGEN Pendant

MLP373PCWTE White

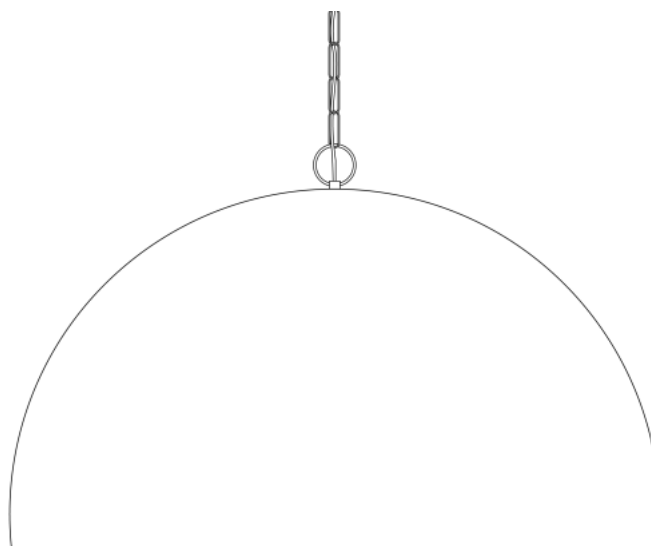

MATERIAL	Aluminium
HEIGHT	46cm 18.11"
WIDTH DIAMETER	73cm 28.74"
LENGTH PROJECTION	n/a
WEIGHT	4.1KG 9.04lbs
LAMPHOLDER	E27 x 1
MAX WATTAGE	60W x 1
VOLTAGE	220/240v
IP RATING	20
CLASS PROTECTION	I
SHADE	-
FLEX BAR CHAIN LENGT	100cm 40"
CABLE TYPE	MLCA029 3 Core Round Black Braid PVC

Fixing Bracket MLROSE15 | White

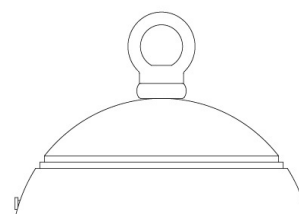
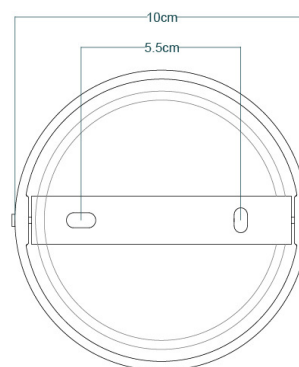

Product Notes:

1) Lamps not included with light fixture. 2) All products are individually hand crafted, therefore may differ slightly within manufacturing tolerances. 3) Please refer to: <http://www.mullanlighting.com/terms> for full list of Terms & Conditions. 4) Cable/Chain can be shortened during installation. 5) Longer Cable/Chain available on request. 6) Additional colour finishes available on request. 7.) Dimensions do not include lamps. 8.) Products wired to UL standards will operate at 110/120v with the appropriate lampholders.

COPENHAGEN Pendant

MLP373PCYLW Yellow

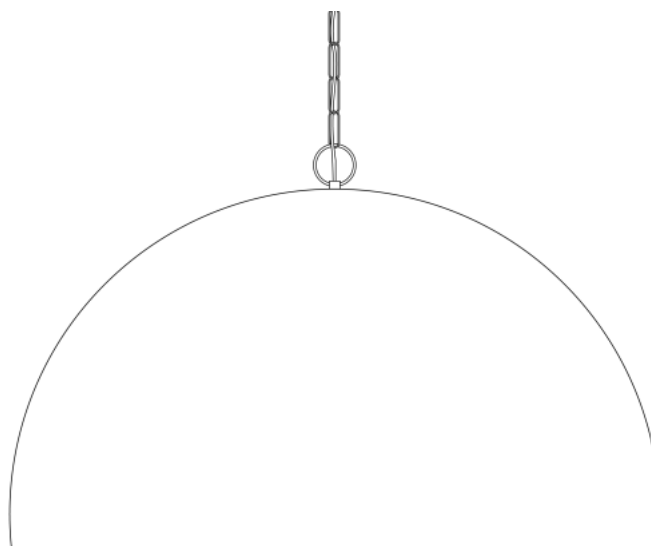

MATERIAL	Aluminium
HEIGHT	46cm 18.11"
WIDTH DIAMETER	73cm 28.74"
LENGTH PROJECTION	n/a
WEIGHT	4.1KG 9.04lbs
LAMPHOLDER	E27 x 1
MAX WATTAGE	60W x 1
VOLTAGE	220/240v
IP RATING	20
CLASS PROTECTION	I
SHADE	-
FLEX BAR CHAIN LENGT	100cm 40"
CABLE TYPE	MLCA029 3 Core Round Black Braid PVC

Fixing Bracket MLROSE15 | Yellow

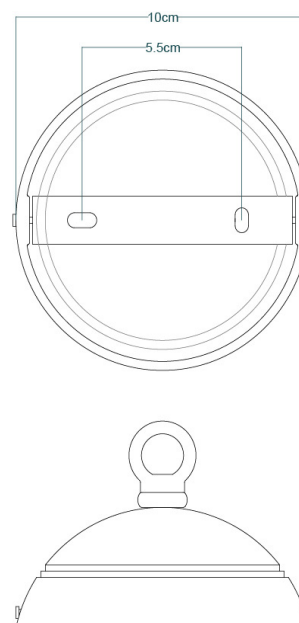

Product Notes:

1) Lamps not included with light fixture. 2) All products are individually hand crafted, therefore may differ slightly within manufacturing tolerances. 3) Please refer to: <http://www.mullanlighting.com/terms> for full list of Terms & Conditions. 4) Cable/Chain can be shortened during installation. 5) Longer Cable/Chain available on request. 6) Additional colour finishes available on request. 7.) Dimensions do not include lamps. 8.) Products wired to UL standards will operate at 110/120v with the appropriate lampholders.