

Della

07076 DEL80-W65

Della flood light IP65 80W 110° 6500K Black

- Models available with asymmetric optic lens
- Long life of 50,000hrs
- Diecast aluminium body
- Surge protection
- 1m of H05RN-F 3 x 1.0mm² cable



Overview

The Della floodlight comes in a range of wattage options and beam angles.



IP65



General Information

Ambient Temperature Range (°C)	-20°C to 50°C
IK Rating	IK08
IP Rating	IP65
Nominal Lifetime (h)	50,000 h
Protection Rating	Class I
Installation Area	External

Technical Summary

Product Code	DEL80-W65
Input Voltage Supply	220-240Vac 50/60Hz
Default Power	80 W
Power Factor	0.99
Default CCT	6,500 K
SDCM of CCT	<6
CRI	≥82
Dimmable	N
Flicker	1%
Lumens Output Maximum	8,000 lm
Maximum Efficiency	100 lm/W
L80B10 Lifetime (h) @Ta 25 °C	40,000 h
Nominal Lifetime (h)	50,000 h
Weight	1.72Kg
Dimensions (L x W x D) (mm)	282x321x38



Kosnic Lighting



KosnicUK



KosnicLightingUK



KosnicUK

Tel: 01635 523 713

Email: sales@kosnic.com

Kosnic.com

07076 DEL80-W65

Accessories

Product Code	Description	Type
KCWP3IN	IP67 in-line connector	Connector kit

Overview

The Della floodlight comes in a range of wattage options and beam angles.

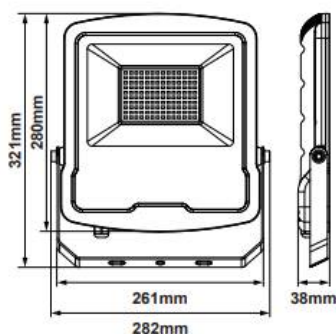

General Information

Ambient Temperature Range (°C)	-20°C to 50°C
IK Rating	IK08
IP Rating	IP65
Nominal Lifetime (h)	50,000 h
Protection Rating	Class I
Installation Area	External



Kosnic Lighting



KosnicUK



KosnicLightingUK



KosnicUK

Tel: 01635 523 713

Email: sales@kosnic.com

Kosnic.com